



International Journal of Occupational and Environmental Safety

BIM as support for design process with fire safety regulations

L. Sanches^a, J. G. F. Abdalla^b, M. A. S. Hippert^c

^aSchool of Architecture and Urbanism, Centro de Ensino Superior de Juiz de Fora, Juiz de Fora, BR (leosanches@yahoo.com.br) ORCID: 0000-0001-7201-2009. ^bSchool of Architecture and Urbanism, Federal University of Juiz de Fora, Juiz de Fora, BR (gustavo.francis@ufjf.edu.br) ORCID: 0000-0002-1555-5004. ^cSchool of Engineering, Federal University of Juiz de Fora, Juiz de Fora, BR (aparecida.hippert@ufjf.edu.br) ORCID: 0000-0003-3604-0111.

Article History

Received 23 January 2017
Accepted 9 June 2017
Published 1 September 2017

Keywords

BIM
parametric design
generative systems
urban regulations
Juiz de Fora/MG/Brazil

DOI:

10.24840/2184-0954_001.001_0004

ISSN:

2184-0954

Type:

Research Article

 Open Access

 Peer Reviewed

 CC BY

Abstract

Based on a case study this research aims to answer if it is possible to, automatically, materialize fire safety standards in 3D forms using algorithmic-design software and also, to analyse means, methods and requirements for its creation. First, with a short literature review it was possible to approach the concepts of BIM and parametric design as well as its use throughout design process, this review was extended to fire safety standards seeking to understand how it defines architectural details in Brazilian state of Minas Gerais. Finally, a digital tool was developed using software Windows Excel and Rhinoceros/Grasshopper, and a set of simulations were made to validate its use. The study showed it is possible to achieve results similar to the ones obtained by conventional methods; therefore, the use of legal constraints as parameters on an algorithm design software may bring more flexibility to design process as it can fasten the design choices validation.

1. INTRODUCTION

The Architecture scenario has considerably changed, as depending on the increasing integration with digital tools, not only as representation platforms, but also as support for project development. According to [Howell & Batcheler \(2005\)](#), the initial approaches between architectural design and computer-aided design (CAD) tools were the drawing tools replacement, while maintaining the already existing representational logic. In a second stage, with the development of 3D tools, the focus of CAD has changed to the visualization of architectural objects. Since then, with the evolution of 3D models, the concept of Building Information Modelling (BIM) has arisen. [Eastman et al. \(2008\)](#), define BIM as “a modelling technology and associated set of processes to produce, communicate, and analyse building models”, i.e. those models are not only the building components itself, but also the data/parameters describing how those components behave, in a consistent, nonredundant and coordinated environment. Summing up, based on the interoperability between tools and agents, BIM seeks to make the three-dimensional model, the core of project development (i.e. Object-Oriented CAD), putting together all the information generated throughout the process.

Parametric design is part of the BIM concept and it is, according to [Henriques & Bueno \(2010\)](#), “a set of rules or logical, geometric and parametric relations, set into a specific sequence, for

solving a specific problem". Howell & Batcheler (2005) argue this design method adds intelligence to the objects, "permitting the representation of complex geometric and functional relationships between building elements".

Geometric complex objects and the design of constructive/structural elements are among the most popular uses of parameterization and generative systems. Aside from them, another possible use of those tools is to take the real constraints interfering with the project as parameters to define the architectural object. Usually the standards and regulations are applied through a series of operations and adaptations to validate the design decisions following repetitive patterns, based on legal parameters. Essentially, this type of task is similar to what Terzidis (2006) define as an algorithm, the act of coding a problem through a finite, consistent and rational set of steps.

Since it can lead to a faster process of validating the design options and, in consequence, contribute to the development of more efficient and safe buildings, it is plausible to explore the generative systems as a support tool throughout design development, aiming to put together both rules and regulations into an adaptable and comprehensive source of information.

The object of this research is a parametric tool developed focused on bringing adequate information concerning legal definitions already in the early stages of the design process. Based on a case study this research aims to answer if it is possible to automatically materialize the fire safety standards in 3D forms using algorithmic-design software and also, to analyse the means, methods and requirements for its creation.

This study has as limitations the fire safety standards concerning emergency exits in the State of Minas Gerais, Brazil. Due to specific requirements, further explored, the research focuses on the number of exits, type of stair definition and, specifically, on the smoke-proof stairwells elements. It is also important to state that, although it does not address all the instances of BIM, this research approaches to its main concept, the act of modelling the information regarding a building.

2. METHODS

In a qualitative experimental and explanatory study, as this research, Prodanov & Freitas (2013), indicate the direct designation of an object of study, a way of observation, and a control situation. The object of study is the parameterization applied to the design process, specifically through a digital tool development. As a way of observation, it was set an objective approach to its results through numerical and visual validation of the solutions. Finally, it was set, as a control situation, a pair of standard projects, one commercial and one residential, using common values for the parameters required by fire safety regulations.

The research development was set in three steps, in the first one; the legal standards were extensively analysed seeking to establish the inputs, outputs and processes composing the problem. The next steps were the tool coding and the simulation/validation of its use. Due to its diverse data managing ways, the tool processes are divided in two different instances. First, the table comparisons and calculations are set in Microsoft Excel spreadsheets. In a second phase, the data obtained is imported by Rhinoceros software, which paired with Grasshopper is responsible of its conversion in 3D figures.

3. LEGAL AND CONCEPTUAL FRAMEWORK

3.1. Short literature review

Lawson (2011) presents a series of discussions about the design process leading to the conclusion that the path from problem to solution is actually a continuous interaction between these two elements, mediated by activities of analysis, synthesis and evaluation, without a specific sequentially set order. Complementing the discussion, Andrade & Ruschel (2011) discusses each of those activities. According to them, the analysis phase is when the main elements of a design problem are identified. The synthesis phase is when creative design concepts are defined, and when constraints and opportunities presented in the synthesis phase

are finally answered. Lastly, the evaluation phase tries to ensure the generated responses are the most appropriate approach to the problem. In this context, it would be possible to assume that the use of BIM, and more specifically the parameterization as explored in this paper could be included as facilitating the negotiations between those phases.

In a more direct approach to the benefits of BIM, [Azhar \(2011\)](#) references the possibility of more appropriate visualization tools, better cost control, and improvements in the management process, among others. For the author, this technology can contribute to better quality projects, since solutions may be rigorously tested, and simulations made in a faster way. Thus, it justifies the development of tools seeking to increase the possibility of faster simulations, especially from legal parameters, which according to [Andrade & Ruschel \(2011\)](#) are the strictest constraints for designs.

According to [Kensek & Noble \(2014\)](#), BIM is a database composed of 3D model, parameterization and interoperability between agents. It is a digital representation of a building's physical and functional characteristics. [Eastman, C. et al \(2008, p.17\)](#) states that "BIM moves the industry forward, from the automation of current design tasks and 'paper-centric' processes towards an integrated workflow based on Interoperability". Thus, its use, seeks to take advantage of the collaboration, computational capacities, web communication and knowledge apprehension, among others, to simulate and manipulate models capable of contributing to decision making not only throughout the design process but also along the construction and the use of a building.

One of the BIM components is the parametric design. As seen before, [Henriques & Bueno \(2010\)](#), states that it "corresponds to the codification of a set of rules, or logical, geometric and parametric relations, in a given sequence, to solve a certain problem". Parametric objects are the main difference between common three-dimensional and BIM models. They were developed in the 1980s and are related to abstract thinking, since they do not have fixed geometries or properties. They are data, rules and mutual relationships based and allow the automation of modifications and adjustments.

Generative design systems are a set of abstract definitions of variations capable of displaying or producing projects, it is not restricted to the application of digital tools though ([Fischer & Herr, 2001](#)). Shape grammars, fractals or cellular automata are some examples of analogue systems that can be possibly defined as generative ([Fischer & Herr, 2001](#); [Shea et al., 2005](#)). However, usually, such digital systems aim to create a new design process capable of producing new spatial, efficient and constructible possibilities by exploiting the current computing and manufacturing resources ([Shea et al., 2005](#)). Summing up, such a concept refers to any project practice, in which the designer uses a system with some level of autonomy to produce solutions to design problems ([Abrishami, Goulding, Rahimian, & Ganah, 2014](#)).

Theoretically, parameterization and generative systems are not, exclusively a tool for total automation, but also can have a supporting role at design process. It may seek to keep the designer in full control of the situation; either of the interactivity with the model or of design decisions itself. It is interesting to understand the specific nature of design, qualitative and quantitative tasks, routine and creative processes can be managed in different ways, using new design tools to take advantage of the human/computer synergy. Thus, parametric modelling could extend capabilities of designers by instigating new ideas and solving difficult tasks.

3.2. Local considerations

In Brazil, there are legal processes to follow before construction actually begin, the municipality and fire safety authorities must approve projects beforehand. According to Brazilian Association of Architecture Practices (ASBEA), the design development phases are, in order: *Preliminary Study*, when survey and analysis of constraints defined by law are set; *Draft*, when technical and legal projects are developed; *Pre-executive and Executive/Detailing*, when design solutions are consolidated, leading to the final version ([Cambiaghi & Amá, 2012](#)). The formalization of a particular product consisting of documents to register design solutions adopted throughout design process define each of those phases. Based on these local definitions, usually the adjustments relating to legal aspects are carried out in the second phase, the Draft – specifically when professionals in charge of different fields integrate the process –. Before that, legal

requirements have a superficial approach, by suggesting hypotheses later evaluated by the designer.

In an analysis of Brazilian legal standards regarding architectural projects, the addressing of legal requirements, happen along design process through validation of design decisions by calculations following repetitive patterns based on defined legal parameters. Those parameters depend, usually on environmental settings such as size and shape of the site, as well as the product itself, and the adopted typology. With that, comes the possibility to automate parameters application, seeking greater freedom and speed in testing of design assumptions, thus, letting only specific project settings in charge of users.

4. TOOL DEVELOPMENT

Almeida (2008) sets that coding an algorithm starts with the problem's organization in three steps: *input* – indispensable data for problem solving –, *processing* – procedures leading to result –, and *output* – initial problem's solution. The formalization of these stages occurs through specific representation methods; one of them, which was chosen for this research, is the flowchart, a representation through conventional geometric symbols, expressing logical reasoning with which the problem is solved (Almeida, 2008).

The flowcharts exposed next, seek to make the whole process visually accessible, and thus, to help understanding the logical path leading to the solution of the problem.

4.1. Fire safety regulations: an overview, and the addressed issues

Fire Departments of each Brazilian state are responsible for fire safety standards, commonly through Technical Instructions (IT). In Minas Gerais State case, the Technical Instruction 08 – IT08 (CBMMG, 2010) is the reference regarding escape routes design for any kind of building.

The process stated at IT08, is a composition of two phases. The first one is the input of design data in a sequence of reference tables to define number of exits and type of stairway (Figure 1). The second one is the design of stairway's specific details like ducts minimum size and its proportions.

In the first phase, based on the type of occupation, buildings are categorized in residential, hosting services, retailer, services, educational and physical culture, public meeting locations, automotive services, health care, industry, storages, explosives, and special uses. The previous categories are further divided in subcategories; varying from two up to eleven. E.g., the residential buildings can be a single-family house, a multi-family or a collective housing. This process defines specific parameters to use in next steps.

Based on specific parameters definitions described above, and together with population data, total floor area, building height, and other construction features, IT08 establishes the type of stairway to use in each building – i.e. a common staircase, a protected stairway, or a smoke-proof stairwell - as well as dimensions required for each case.

In the second phase the stairway type previously defined have its details further developed. The first two types, common staircase and protected stairway, have a relatively low degree of complexity. Thus, this study focuses on smoke-proof stairwells, since an extensive series of coordinated parameters define their elements.

The ventilation ducts are the main elements of smoke-proof stairwells. Its size and proportions are a significant influence to building's core design. The process used to define their dimensions starts with a simple operation – number of floors times a constant number – to obtain its area. After that, the designer freely defines their width and length, its only limitation is the 1:4 proportion between dimensions (Figure 2). The end of the process established by IT08 are specific definitions that does not interfere with volumetric design, but define size and positions of inlet/outlet ducts' openings.

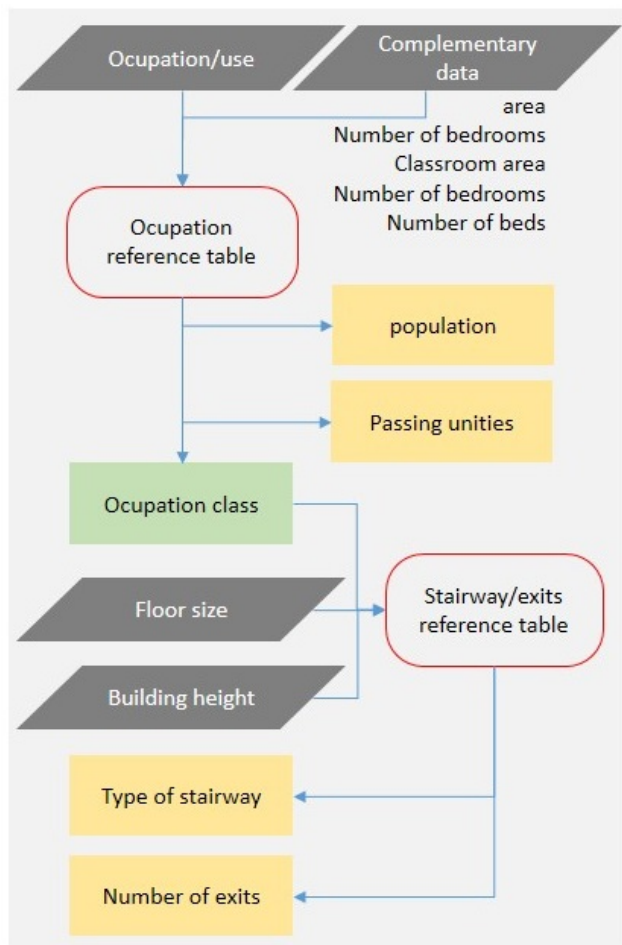

Figure 1. Type of stairway and number of emergency exits flowchart.

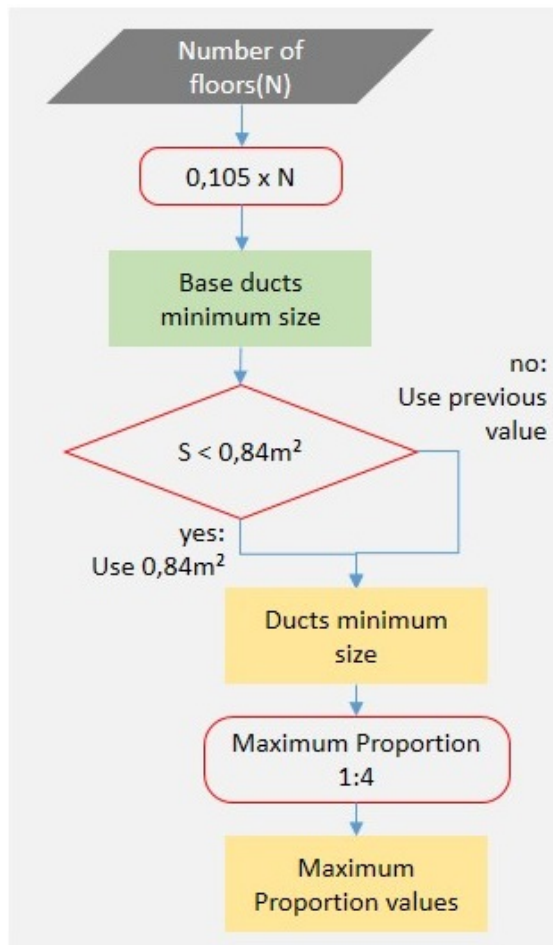

Figure 2. Ducts minimum size and maximum proportions allowed.

4.2. Report on the tool development

As stated before, the tool developed in this research takes advantage of Microsoft Excel and Rhinoceros/Grasshopper integration to fit specific needs of both types of operation present in the process, the calculations based on tables and standards, and the 3D forms generation.

Firstly, fire safety standards and laws were set on Microsoft Excel, using a group of integrated sheets that are responsible for automating all classifications and calculations in the process. Thus providing information based on parameters required by fire safety regulations, in a consistent way. The inputs on this sheet are the data required by legislation: classification of buildings by its type of occupation, total floor area, building height, number of floors, floors height, construction characteristics, number of bedrooms, and area. The operations on Microsoft Excel are set in seven spreadsheets, assorted in (1) inputs/outputs, (2) database, and (3) references and calculations.

The (1) input/output sheet is the only user interface needed in this part of the process. That sheet is where the user inserts data regarding the design, and where the software presents its results. As seen before, the process of making the design fit the regulations of IT08 is set through series of phases comparing design definitions with specific tables. Parameters required for each phase change depending on results of previous phases. Based on these requirements, the spreadsheet uses a certain number of dynamic cells, which are set to guide the user in inserting the right parameter for the software to consider. For instance, the spreadsheet asks for the number or bedrooms in a residential study and for the floor area in a commercial case.

The (2) database defines classifications and parameters to be adopted in each step, and comprises five spreadsheets storing law standards and references. In this part, besides from storing information regarding regulations, the software is set to establish comparisons and to

change information on the user interface, as seeking to guarantee the correct input from the user. Finally, the (3) calculation spreadsheet represents the system's main engine, which is responsible for every calculation in the process.

After all operations, the outputs of the spreadsheet are the estimated population, the type of stairway indicated, and the number of required escape routes. In addition, it also returns the dimensions of the following items: access hallways, escape routes, stairways, ramps, and doors. Lastly, it presents dimensions of inlet and outlet ducts, and their required openings in each floor.

Based on Excel outputs, the second part of the tool is an algorithm developed in Grasshopper/Rhinoceros software to simulate a 3D representation of the situation in study (Figure 3). The algorithm starts by importing the outputs of Excel using a spreadsheet reader. The imported parameters are total floor area, building height, number of floors, floors height and ducts dimensions. After that, a data tree is set to divide the various items imported, and to redirect information to operators in charge of creating geometric figures representing the horizontal projection of ventilation ducts. Based on those figures, and on excel outputs, the algorithm establishes the distance and the course to be followed in the extrusion operation, which finally creates 3D forms representing the architectural objects in development. That process is set to take place either for inlet and outlet ducts.

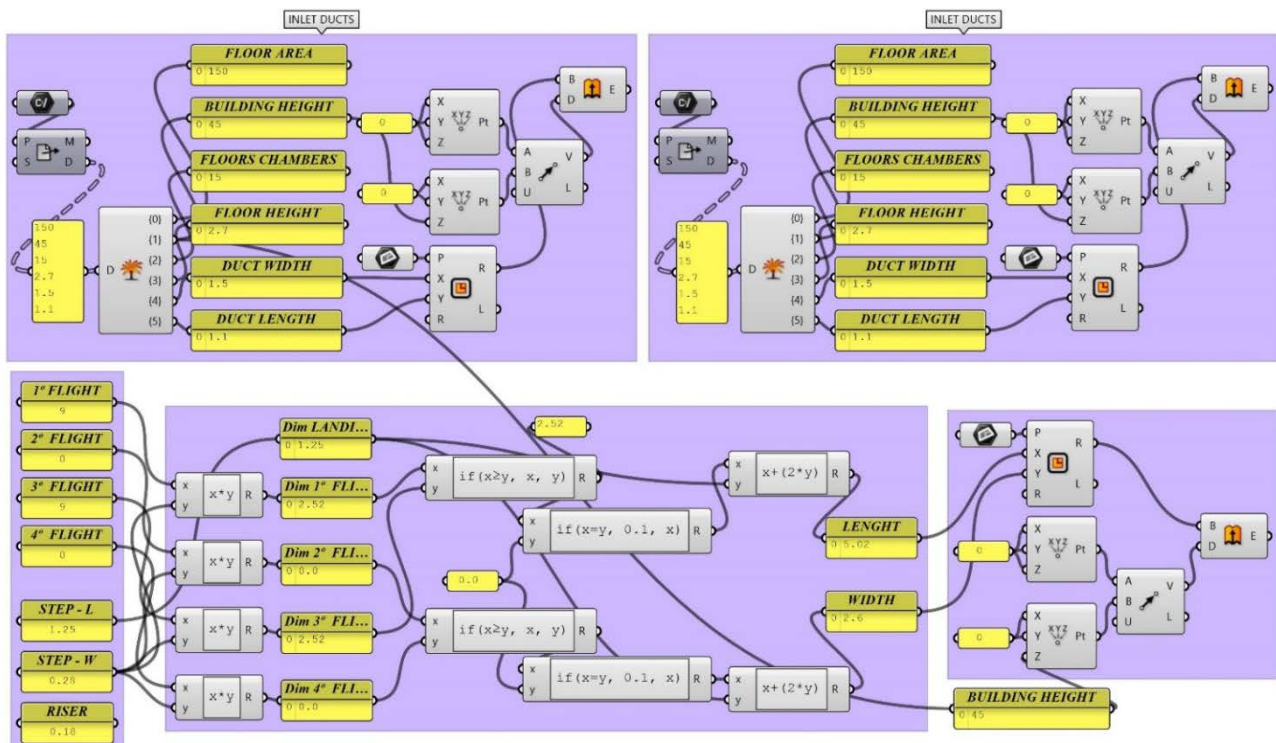

Figure 3. Algorithm used in Grasshopper to create de inlet/outlet ducts and the stairwell.

The stairwell definitions are set in a different manner. The user inputs the number of steps on the stairway, the width, the tread and the riser size of stairs. After that, the algorithm processes the information, and thus defines the stairway characteristics, like flight of stairs and landings. Finally, based on this information, and the building height, it generates the 3D representation of the stairwell. After this process, Grasshopper provides three volumes: the stairwell, the inlet, and the outlet ducts. The user now can visualize legal requirements for the product in design continuously, providing an instant answer to every scenario he/she wishes to test.

4.3. Simulation definitions

To test the simulation tool, two hypothetical buildings were used. These two buildings, one commercial/services and the other residential, where chosen in order to explore the tool at two of the most common types of occupation in the city of Juiz de Fora, at Minas Gerais state. The parameters following were set for this study (Table 1):

Table 1. Parameters used on the simulations.

	residential	commercial and services
Floor area	150m ²	150m ²
Building height	33m	45m
Number of anterooms	11	15
Floor to ceiling distance	2,7m	2,7m
Number of bedrooms	3	-
Area	-	120m ²

4.4. Results obtained

From initial design definitions, Grasshopper algorithm paired with Excel spreadsheet automatically generates 3D figures, materializing the requirements for stairwell and the inlet/outlet ventilation ducts. The tool produces outputs immediately upon data entry. The 3D volumes thus became available for using on Grasshopper, and also to export it for other software used on design development, such as ArchiCAD or SketchUp.

The required use of different tables for defining types of building and population, as well as the need for a series of comparisons with reference values, can make the conventional process slower than that observed with the software's aid. In addition, defining ventilation ducts dimensions and their openings by each floor depends on a series of calculations for every new possibility in test. The comparison between the two methods showed that the results obtained with the software (Table 2), were able to achieve the same values as conventional method, pointing out that it would be possible to develop tools to support design process, as addressing fire safety rules.

Table 2. Result obtained with the digital tool.

	residential	commercial and services
Population	6	18
Type of stairs	smoke proof	smoke proof
Number of exits	1	1
Ducts area	1,155m ²	1,575m ²
Width	0,537m	0,627m
Length	2,149m	2,510m
Chosen Width	1,10m	1,50m
Chosen Height	1,10m	1,10m
Duct opening height	0,70m	0,70m
Duct opening width	1,20m	1,20m

The automation of calculations and especially of the sequence of comparisons with reference values was instantaneous. Although different platforms were necessary, outputs were instantaneous for every design choice, pointing that it could have a support role on decision-making throughout the design process. The results presented are a basic design of security features, without providing a definitive solution on how to set these elements in the project (Figure 4 and Figure 5).

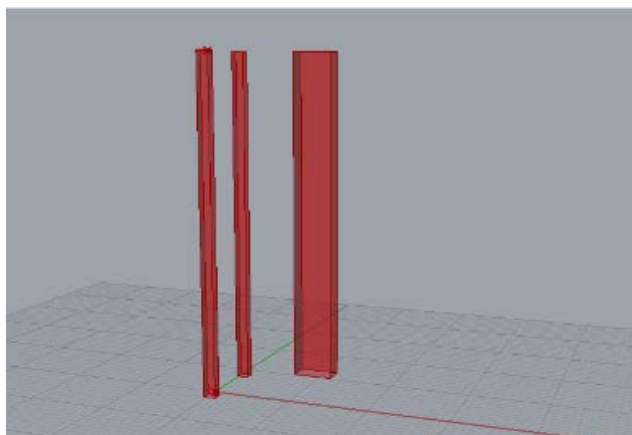
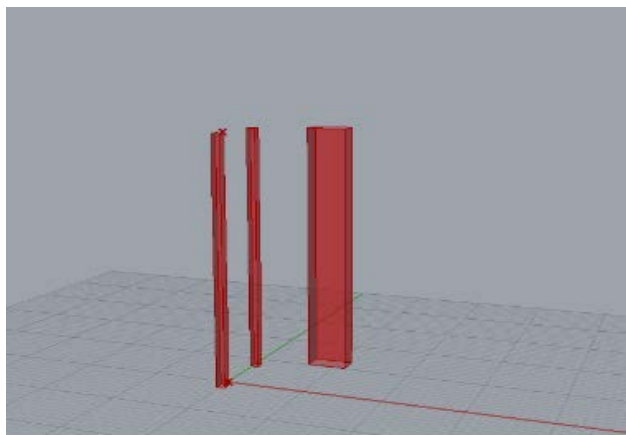
**Figure 4.** 3D model - commercial study.**Figure 5.** 3D model - residential study.

4.5. Analyses

Based on this research, the analysis of the tool development process is presented emphasizing four distinct themes: (1) legal standards, (2) product, (3) algorithm creation process and (4) usability.

Regarding the (1) legal standards, the whole process presented in IT08 depends on the search for information, and the assessment with a series of reference tables, as well as a sequence of simple mathematical operations. The algorithm explored in this research can automate those assessments and operations, making the process of testing design hypotheses practically instantaneous with the changes on input data.

When dealing with the (2) product itself, the parameters presented in IT08 can be characterized as volume generators – i.e., defining an area to be built from initial data. The algorithmic method was able to cover those parameters directly. The sequence of decisions/operations leading to the materialization of legal requirements follow a linear path, making the process relatively simple in terms of coding. In terms of values achieved with the algorithm, those were similar to the ones achieved through conventional methods, which may demonstrate that the development of digital automation and legal checking tools may contribute to improve the efficiency on decision making throughout the design process.

The (3) algorithm creation process, in comparison with usual architectural methods, requires different knowledge and different ways of thinking, combining the usual technical skills in architecture and urbanism to coding/programming knowledge. [Kilkelly \(2015\)](#) says architects focuses on problems solving in a creative and subjective way, however, some problems require a rigorous and objective approach. In this scenario, unlike a complete design, the buildings emergency exits are set to algorithmic problem solving approach. The definitions on this kind of architectonic detail are based on technical requirements. In this type of component, the subjective aspect is considerably small, so the use of a generative algorithm can provide support to decision-making process, and not as a source of automatic sets of design solutions in substitution for architect's creative process.

Usability (4) is related to optimization of the interaction between people and products so they are pleasant, effective to use and easy to learn from the user perspective ([Preece et al., 2011](#)). The tool explored in this study is set to qualified access, thus its users need prior knowledge of software in use – Excel and Grasshopper. Also, as in a research phase, the tool is presented in an open version, therefore calculations, search engines, and the algorithm visual interface itself are accessible for users; this kind of exposure may lead to unwanted editions and even intentional changes that may interfere with connections between the parts composing the tool's framework. In future versions, is necessary to make the user experience happen directly, and specifically, on the inputs.

5. CONCLUSION

From this study, it can be assumed that in addition to formal experimentation, the use of parameterization based on legal standards and regulations may bring benefits to the design process, since the production of various solutions may become faster. A major advantage of this tool is the possibility of inserting technical decisions in early stages of design process, since it brings greater clarity to the designer, as regarding constraints that at some point must be applied to architectural objects.

In contrast, a weakness of the parameterization tool compared to conventional methods is not properly in itself or in its use, but in its development instead. An extensive analysis of law and standards is required as well as an advanced knowledge of calculation and parameterization software. This fact may point, in this case, the importance of architect's expertise as a designer, together with the technical expertise on spreadsheets and software tools development. It is also noticed the need for an adaptation of the agents to the requirements of these new tools. To implement this tool in the design process of architecture practices, it is required a basic knowledge of Windows Excel and Grasshopper, in addition to usual platforms.

6. FUTURE STUDIES

This research is an initial approach to the topic, as part of a wider study already in development. The algorithm of the main research focuses on cities' building codes, aiming on parameters with a significant impact on architectural form, specifically on the urban standards for building height, floor area, and total area allowed. By generating 3D volumes for entire buildings, it focuses not only on simulation of specific objects, but also on simulating the city occupation, thus contributing to both, architectural and urban design process (Figure 6).

In addition, along the research, it was observed that the personal responsible for coding the regulations have acquired an extensive knowledge about the matter. Therefore, an emerging theme to explore in future studies is the educational potential of developing an algorithm based on legal requirements or other specific design constraints.

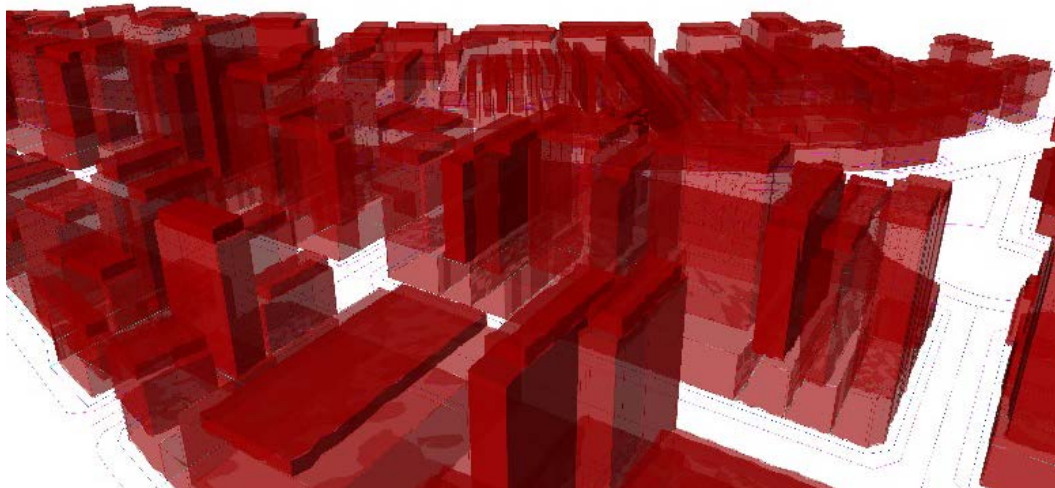

Figure 6. Simulation of the city (Aanches, 2017).

REFERENCES

- Abrishami, S., Goulding, J. S., Rahimian, F. P. & Ganah, A. (2014). *Integration of BIM and generative design to exploit AEC conceptual design innovation*. Journal of Information Technology in Construction (itcon) 19, 350-359.
- Almeida, M. (2008). *Curso essencial de lógica de programação*. São Paulo: Digerati Books.
- Andrade, M. L. V. X. & Ruschel R. C. (2011). *Building Information Modeling (BIM)*. In Kowaltowski, D. C. C. K. et al. *O Processo de Projeto Em Arquitetura da Teoria à Tecnologia*. São Paulo: Oficina de Textos.
- Azhar, S. (2011). Building Information Modeling (BIM) trends, benefits, risks, and challenges for the AEC industry. *Leadership and Management in Engineering* 11(3), 241–252.
- Cambiaghi, H. & Amá, R. (2012). *Manual de escopo de projetos e serviços de arquitetura e urbanismo*. São Paulo: ASBEA - Associação Brasileira de Escritórios de Arquitetura.
- CBMMG - Corpo de Bombeiros Militar de Minas Gerais. (2010). *Instrução Técnica 08 - Saídas de emergência em edificações*. Belo Horizonte: CBMMG.
- Eastman, C., Teicholz, P., Sacks, R. & Liston, K. (2008). *BIM Handbook: A guide to building information modeling for owners, managers, designers, engineers and contractors*. Hoboken: Wiley.
- Fischer, T.; Herr, C. M. (2001). *Teaching generative design*. Proceedings of the 4th International Generative Art Conference. Milan: Politecnico di Milano University.
- Henriques, G. C. & Bueno, E. (2010). *Geometrias complexas e desenho paramétrico*. Drops 030(08).

- Howell, I. & Batcheler, B. (2005). Building information modeling two years later — Huge potential, some success, and several limitations. *The Laiserin Letter* 24.
- Kensek, K.; Noble, D. (2014). *Building information modeling: BIM in current and future practice*. Hoboken: Wiley-Blackwell.
- Kilkelly, M. (2015, April 5). *5 razões para arquitetos aprenderem programação*. Retrieved December 20, 2016, from <http://www.archdaily.com.br/br/764687/5-razoes-de-porque-os-arquitetos-devem-aprender-a-programar-sofwares>.
- Lawson, B. (2011). *Como arquitetos e designers pensam*. São Paulo: Oficina de Textos.
- Preece, J., Rogers, Y. & Sharp, H. (2011). *Interaction desing: beyond human-computer interaction*. Chichester: J. Wiley & Sons.
- Prodanov, C.C. & Freitas, E.C. (2013). *Metodologia do trabalho científico: métodos e técnicas da pesquisa e do trabalho acadêmico*. Novo Hamburgo: Editora Feevale, 2^a ed.
- Sanches, L. (2017). *Parametrização e sistemas generativos como apoio à tomada de decisões em projetos de arquitetura aplicados à legislação urbana da cidade de Juiz de Fora*. Juiz de Fora: UFJF. Master's Thesis.
- Shea, K., Aishb, R. & Gourtovaia, M. (2005). *Towards integrated performance-driven generative design tools*. *Automation in Construction*, v. 14, n. 2, 253–264.
- Terzidis, K. (2006). *Algorithmic Architecture*. Routledge: Nova York.